

PIA DE ENCAIXE VERONA HE

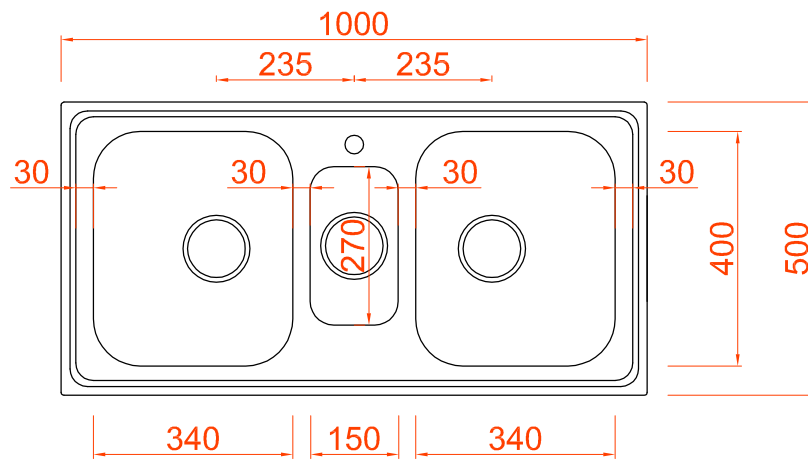

Versão sobrepor.

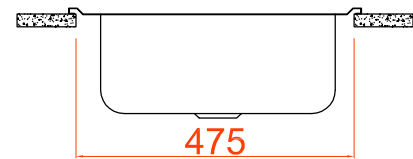
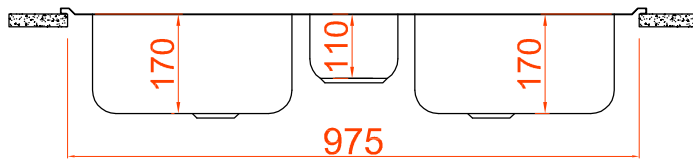

Versão embutir.

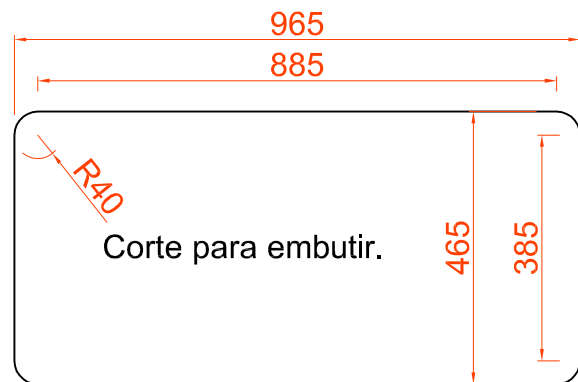
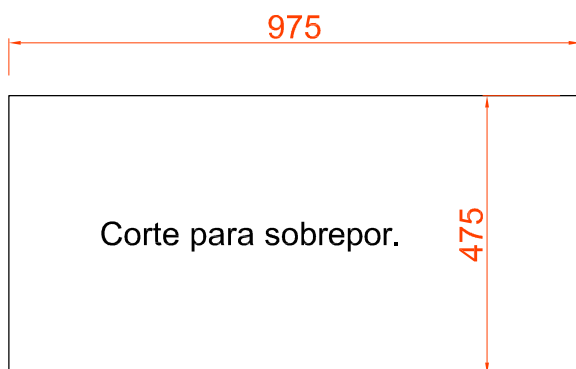
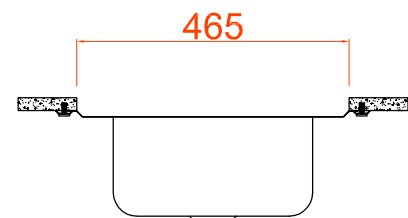
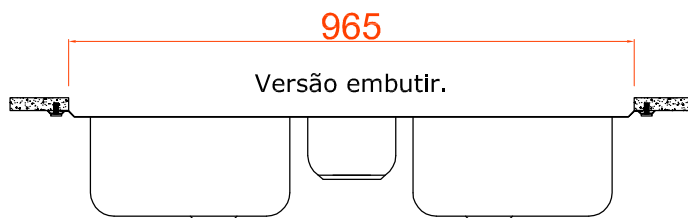

Ref.

PIA DE ENCAIXE VERONA HE

Material	Esp.	Prof. "A"	Acabamento	Furação Válvula	Anti-ruído
AISI304	1,0mm	170/110mm	Brilhante/Escovado	Ø4 ½"	Sim

Acessórios Opcionais:

